





# INSTALLATION HANDBOOK

## FIXED LADDERLINKS

*Extract from Installation of SafetyLink Anchor Points*  
(Complete Installation Guide available from website [www.safetylink.com](http://www.safetylink.com))

SafetyLink is an innovative anchor company achieving success and keeping you safe whilst working at heights.

-  ROOF ANCHORS
-  HORIZONTAL LIFELINES
-  PERMANENT LADDERS
-  LADDER STABILISERS
-  TEMPORARY ANCHOR



Read entire handbook before installing SafetyLink products. All products must be installed in accordance with SafetyLink's installation handbook, using only products supplied by SafetyLink Pty Ltd. Failure to follow all warnings and instructions may result in serious injury or death.



SafetyLink Pty Ltd  
**AU: 1300 789 545**  
**INT: +61 2 4964 1068**  
FAX: +61 2 4964 1069  
[info@safetylink.com](mailto:info@safetylink.com)

[www.safetylink.com](http://www.safetylink.com)

# INSTALLATION OF SAFETYLINK FIXED LADDERLINKS

**WARNINGS.....3**

**MAINTENANCE – PERIODIC INSPECTIONS.....3**

    FIXED LADDERLINK: LADDER SUPPORT BRACKET ..... 3

**WARRANTIES.....4**

**FIXED LADDERLINK – LADDER SUPPORT BRACKETS.....5**

**FIXED LADDERLINK – METAL ROOF LADDER SUPPORT BRACKET.....6**

    INSTALLATION FOR METAL ROOFS – UNDER ROOF SHEETING..... 6

**FIXED LADDERLINK – METAL ROOF LADDER SUPPORT BRACKET.....7**

    INSTALLATION FOR METAL ROOFS – ON TOP OF ROOF SHEETING..... 7

**FIXED LADDERLINK – TILED ROOF LADDER SUPPORT BRACKET.....8**

    INSTALLATION FOR TILED ROOFS ..... 8

**FIXED LADDERLINK – WALL MOUNTED LADDER SUPPORT BRACKET.....9**

    FIXING TO TIMBER WALL/PARAPET..... 9

    FIXING TO CONCRETE WALL/PARAPET..... 9

**APPENDIX – DIAGRAM 2 – ANCHOR POSITIONING LAYOUT.....10**

**EXPERT FALL PROTECTION PLANNING.....11**

**IN CASE OF ACCIDENT.....12**

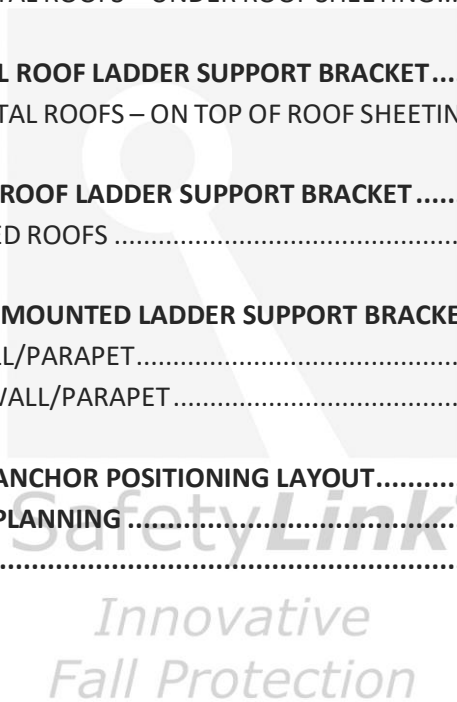

Safety Centre Training



Installation Guide



Video Installation  
METAL ROOF



Video Installation  
TILE ROOF



Catalogue



## WARNINGS



### READ CAREFULLY SOMEONE'S LIFE DEPENDS ON IT

The building or structure for the anchorages should be assessed by an engineer, unless it is clear to a competent height safety installer that the anchorages system is structurally adequate.

**INSTALLATION MUST BE CARRIED OUT BY, OR UNDER THE SUPERVISION OF A COMPETENT HEIGHT SAFETY INSTALLER**

**STANDARD EYEBOLTS MUST ONLY BE USED AS A FALL ARREST ANCHOR.  
ABSEILING EYEBOLTS ARE TO BE USED FOR ROPE ACCESS (ABSEILING).  
SURFACE MOUNTED ANCHORS MUST NOT BE USED FOR ROPE ACCESS (ABSEILING).**

When installing anchor points all safety procedures must comply in accordance with the current safety code/s of practice/s for working at heights.

- Recommended waterproofing for roof tiles: *Sika Flex Co-Polymer Sealant*.
- Recommended waterproofing for metal roof: *Silicone Sealant*.
- All threads must be coated with Loctite prior to assembly. (IMPORTANT NOTE: Before applying Loctite 243 use Loctite 7471 primer to activate the surface according to manufacturer's instructions).
- A personal energy absorber or a fall-arrest device with a personal energy absorber must be used to connect to all SafetyLink Anchorages and (or) Strops.

## MAINTENANCE – PERIODIC INSPECTIONS

All items of equipment which are in regular use shall be subjected to periodic inspection and servicing. These regular scheduled inspections and servicing must be carried out by a competent height safety installer.

### FIXED LADDERLINK: LADDER SUPPORT BRACKET

**ALL LADDERLINKS MUST BE INSPECTED EVERY 12 MONTHS, INSPECTIONS NEED TO BE CARRIED OUT BY A COMPETENT HEIGHT SAFETY INSTALLER.**

Procedures to be followed at inspection time:

- Visually inspect ladder support brackets for any signs of deterioration or the protective coating being removed. (*Note: LadderLink is made from marine grade aluminium and therefore should not corrode*).
- Ensure LadderLink is firmly secured to the structure as per SafetyLink Installation Handbook. (*refer to Installing LadderLink in Handbook*).

**IN ADDITION TO SAFETYLINK PTY LTD EQUIPMENT, ALL ANCILLARY EQUIPMENT MUST BE INSPECTED IN ACCORDANCE WITH APPLICABLE REGULATORY REQUIREMENTS AND THE MANUFACTURER'S INSTRUCTIONS.**



**FOR MAINTENANCE ADVICE AND SERVICES PLEASE CONTACT SAFETYLINK  
ON +61 249 641068 OR 1300 789545 FOR YOUR NEAREST SAFETYLINK INSPECTION SERVICE  
CENTRE OR EMAIL: [info@safetylink.com](mailto:info@safetylink.com)**



# WARRANTIES

## EXTRACT: SafetyLink Pty Ltd STANDARD TERMS AND CONDITIONS

- 11.1 To the extent permitted by law all implied conditions, warranties and undertakings are expressly excluded.
- 11.2 Except as provided in this clause the Company shall not be liable for any loss or damage, whether direct or indirect (including consequential losses or damage) arising out of any breach of contract by the Company or any negligence of the Company, its employees or agents.
- 11.3 Should the Company be liable for a breach of a guarantee, condition or warranty implied by the Australian Consumer Law (not being a guarantee, condition or warranty implied by sections 51, 52 and 53 of that Law) then its liability for a breach of any such condition or warranty express or implied shall be limited, at its option, to any one or more of the following.
- A) in case of Goods
- (I) the replacement of the Goods or the supply of equivalent Goods.
  - (II) the repair of the goods,
  - (III) the payment of the cost of replacing the Goods or acquiring equivalent Goods.
  - (IV) The payment of the cost of having the Goods repaired.
- Provided that any such Goods are returned to the Company by the Purchaser at the Purchaser's expense.
- B) in the case of services
- (i) the supply of the services again,
  - (ii) the payment of the cost of having the services supplies again.
- 11.4 The Company will not liable for the costs of recovery of the Goods from the field, loss of use of the Goods, loss of time, inconvenience, incidental or consequential loss or damage, nor for any other loss or damage other than as stated above, whether ordinary or exemplary, caused either directly or indirectly by use of the Goods.
- 11.5 The Company warrants that at the time of shipment, Products manufactured by it will be free from defects in material and workmanship. In the absence of a modified written warranty, the Company agrees to making good any such defects by repairing the same or at the Company's option by replacement, for a period of (1) one year from the date of shipment. This limited warranty applies provided that:
- (a) defects have arising solely from faulty materials or workmanship;
  - (b) the Products have not received maltreatment, inattention or interference;
  - (c) **the Products have been installed in accordance with the Company's Installation Handbooks using only products supplied by the Company;**
  - (d) accessories used with the Products are manufactured by or approved by the Company;
  - (e) the Products are maintained in accordance with Australian Standard 1891.4 (section 9).
  - (f) you notify any claim under this warranty to SafetyLink in writing to the address below no later than 14 days after the event or occurrence concerning the produce giving rise to the claim and you pay all costs related to your claim.

This warranty does not apply to any defects or other malfunctions caused to the Goods by accident, neglect, vandalism, misuse, alteration, modification or unusual physical, environment or electrical stress.

Please note that the benefits to the purchaser (as a consumer) given by this warranty are in addition to your other rights and remedies under the Australian Consumer Law. Our goods come with guarantees that cannot be excluded under the Australian Consumer Law. You are entitled to a replacement or refund for a major failure and compensation for any other reasonably foreseeable loss or damage. You are also entitled to have the goods repaired or replaced if the goods fail to be of acceptable quality and the failure does not amount to a major failure.

- 11.6 If any goods are not manufactured by the Company, the guarantee of the manufacturer thereof shall be accepted by the Purchaser as the only express warranty given in respect of the goods.
- 11.7 Except as provided in this clause 11, all express and implied warranties, guarantees and conditions under statute or general law as the merchantability, description, quality, suitability or fitness of the Products for any purpose or as to design, assembly, installation, materials or workmanship or otherwise are hereby expressly excluded (to the extent to which they may be excluded by law).

**PLEASE SEE SAFETYLINK PTY LTD FULL STANDARD TERMS OF CONDITIONS OF SALE FOR FURTHER REFERENCE.**



## FIXED LADDERLINK – LADDER SUPPORT BRACKETS



Product Code: LADFX001



Product Code: LADFX002



Product Code: LADFX003

All safety procedures must comply in accordance with the current safety code(s) of practice(s) for working at heights. Ensure safety at all times during and after installation by using an appropriate height safety protection system.

- ⚠ Adjusting the pitch of the LadderLink to suit steeper roof pitches may be required. This must be completed with an appropriate sheet metal bending machine only. LadderLink's are made from high tensile aluminium, the bender must be set on a high radius to prevent cracking. Failure to do so may result in a damaged and unsafe ladder bracket.
- ⚠ Always use a leash in conjunction with securing points on the LadderLink to secure your ladder once fitted to a ladder bracket.
- ⚠ Protective coating must not be removed.

### Fixed LadderLink: Safe Ladder Access

Made from marine grade aluminium the LadderLink is designed to support a ladder, stopping sideways movement and therefore holding the ladder in place safely. In addition the LadderLink has securing points to tie off the ladder providing a safe access point.

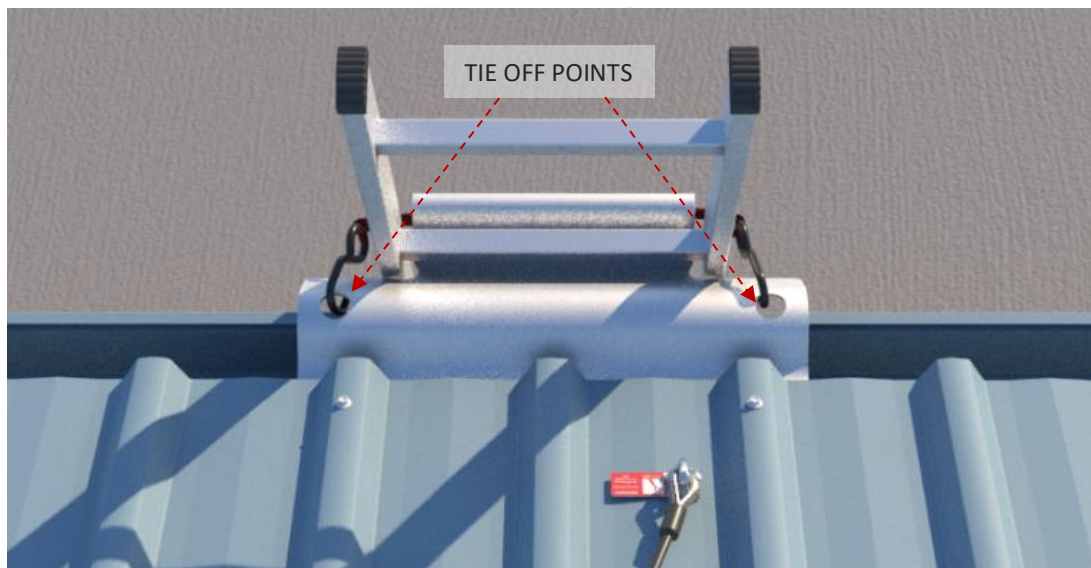

# FIXED LADDERLINK – METAL ROOF LADDER SUPPORT BRACKET

## INSTALLATION FOR METAL ROOFS – UNDER ROOF SHEETING

1. To install the LadderLink simply remove existing hex head roofing screws along the bottom edge of the roof sheeting at the desired location.
2. Slide the ladder bracket under the roof sheeting between the sheeting and batten as shown in the diagram below.
3. Position the ladder bracket so the rolled section is centred over the gutters front edge.
4. Once the ladder bracket is in the desired location, re-install the hex head roofing screws through the original holes, through the ladder bracket and into the roof batten below.
5. Ensure that a minimum of three (3) x 12g 65mm roofing screws anchor the ladder bracket to the structure (recommended to pilot drill holes).

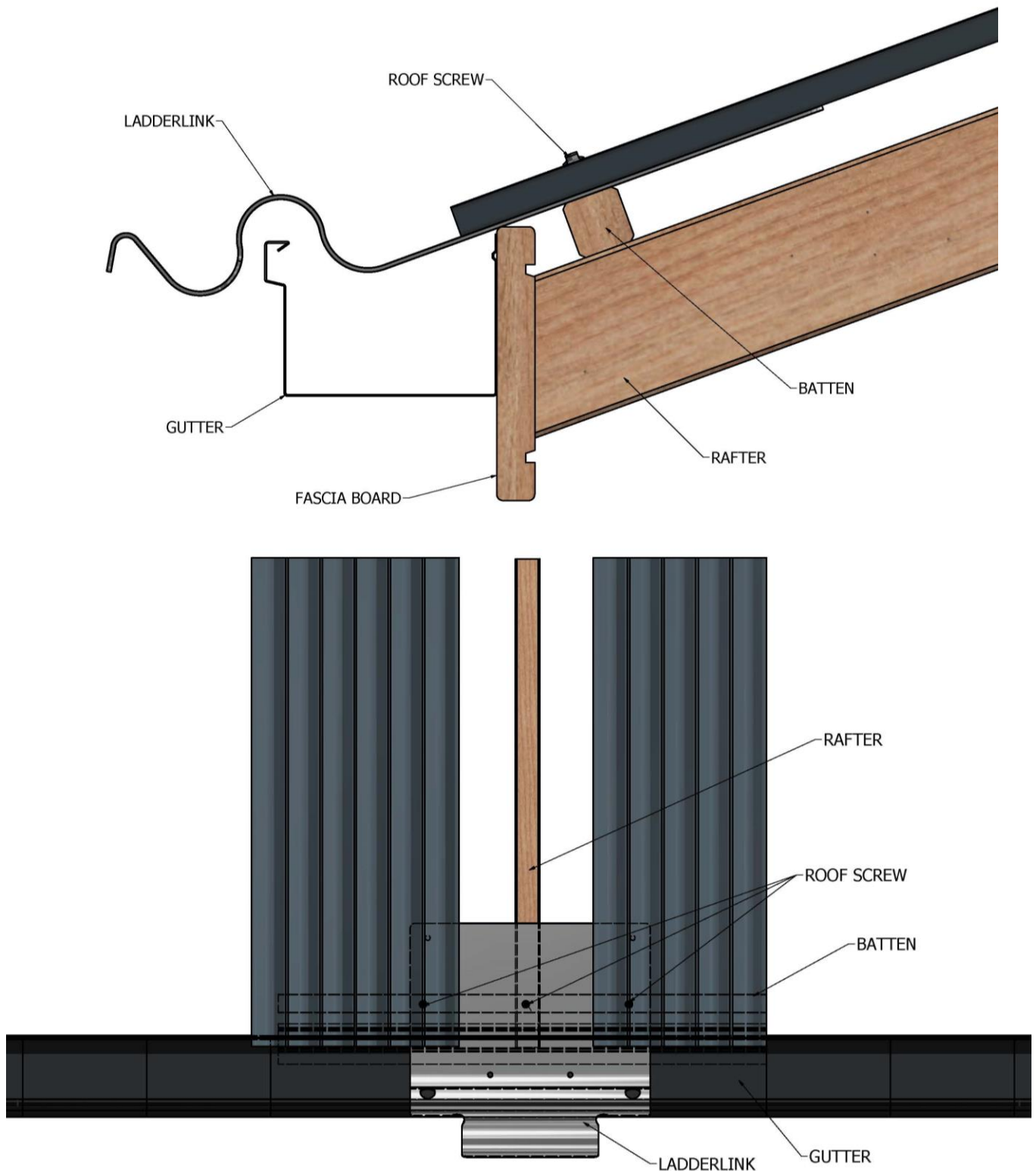

# FIXED LADDERLINK – METAL ROOF LADDER SUPPORT BRACKET

## INSTALLATION FOR METAL ROOFS – ON TOP OF ROOF SHEETING

1. To install the LadderLink simply remove existing hex head roofing screws along the bottom edge of the roof sheeting at the desired location.
2. Place the ladder bracket on top of the roof sheeting as shown in the diagram below.
3. Position the ladder bracket so the rolled section is centred over the gutters front edge.
4. Once the ladder bracket is in the desired location, re-install the hex head roofing screws through the ladder bracket, ensure the screws go through the roof sheeting and into the roof batten below.
5. Ensure that a minimum of three (3) x 12g 65mm roofing screws anchor the ladder bracket to the structure (recommended to pilot drill holes).
6. Install an additional two (2) x 8mm Rivets at the top corners 50mm down from the top edge, see below diagram. This must be completed to prevent rocking of the ladder bracket.

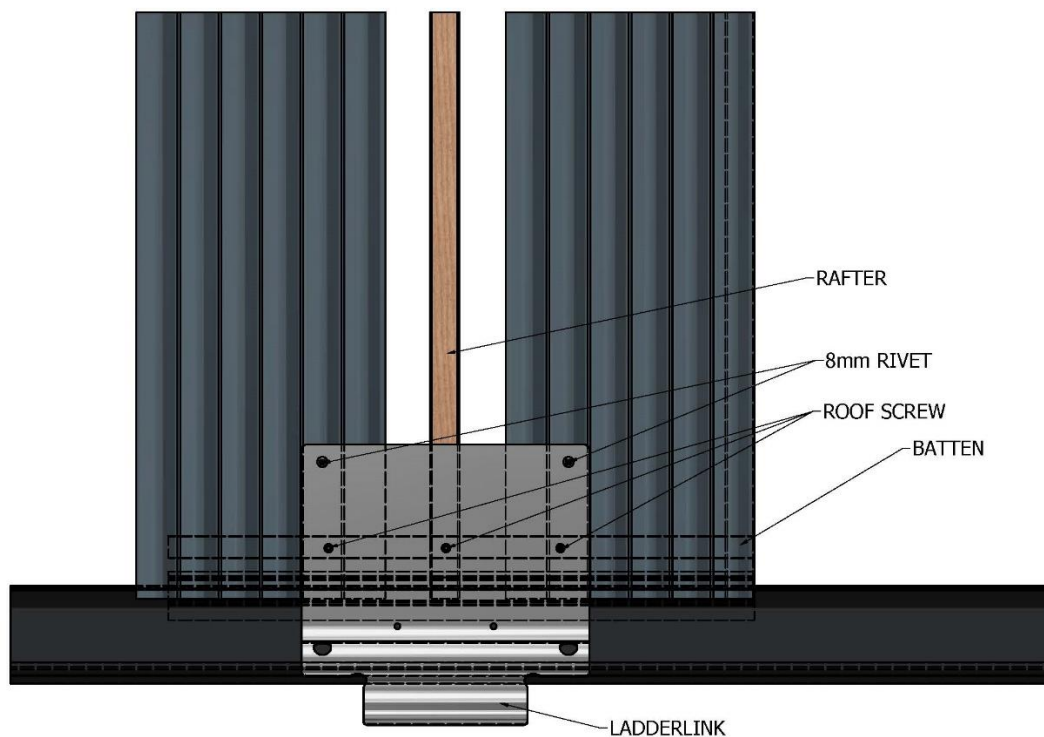
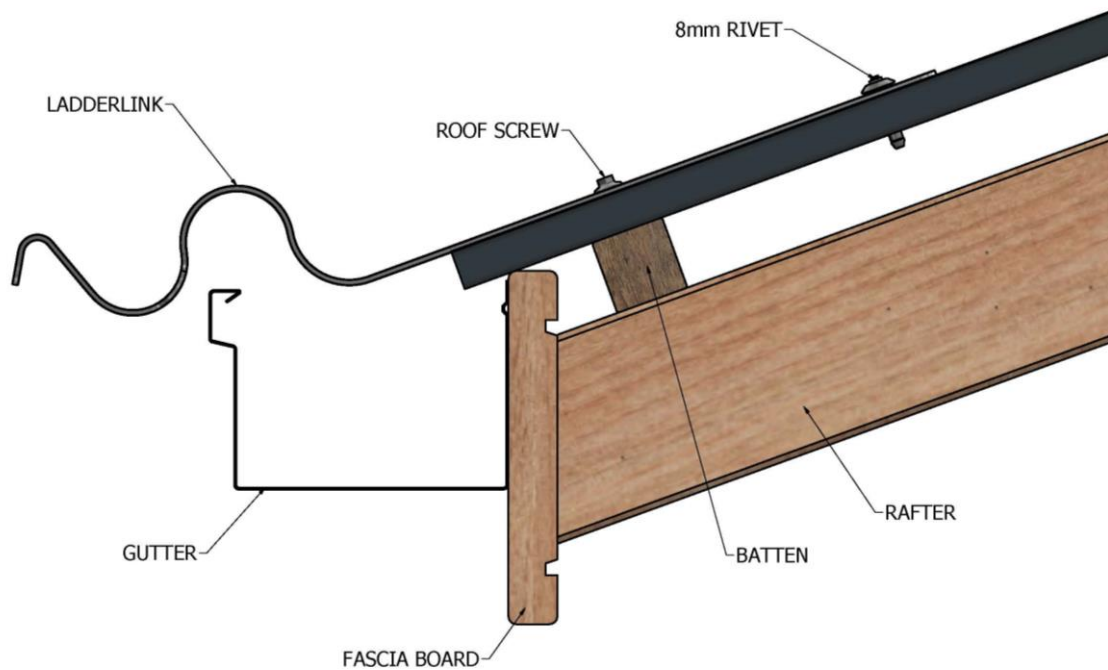

# FIXED LADDERLINK – TILED ROOF LADDER SUPPORT BRACKET

## INSTALLATION FOR TILED ROOFS

1. To install the LadderLink simply remove roof tiles at the desired location.
2. Place the ladder bracket onto the batten, ensure a rafter is centred below the ladder bracket.
3. Adjust the ladder bracket so the rolled section is centred over the gutter's front edge, as shown in the diagram below.
4. Once the ladder bracket is in the desired location, install three (3) x 65mm 12g hex head roofing screws through the ladder bracket and into the roof batten below (recommended to pilot drill holes).
5. Cut a short tile batten to fit as a spacer under the ladder bracket between the rafter and LadderLink.
6. Using one (1) x 100mm 14g hex head roofing screw, anchor the ladder bracket to the rafter below (recommended to pilot drill holes). This should be centred and installed 50mm down from the top edge of the ladder bracket (see below diagram).
7. Ensure that a minimum of three (3) x 12g 65mm and one (1) x 14g x 100mm roofing screws anchor the ladder bracket to the structure.
8. Ensure the timber structure is secured in accordance with current Building Codes.

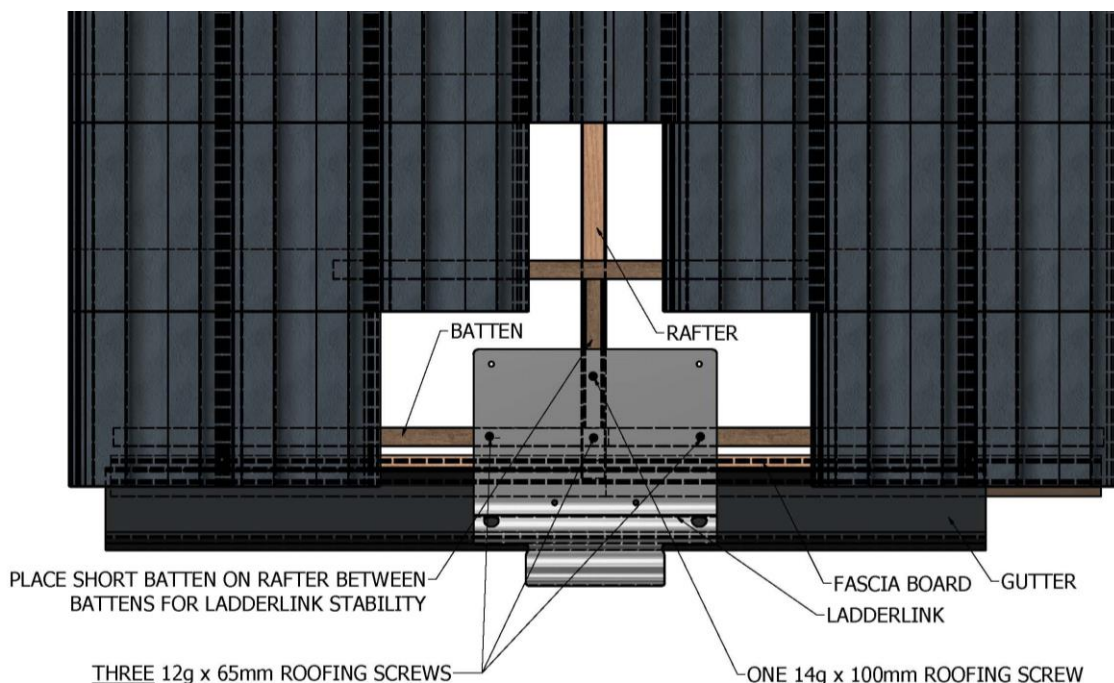
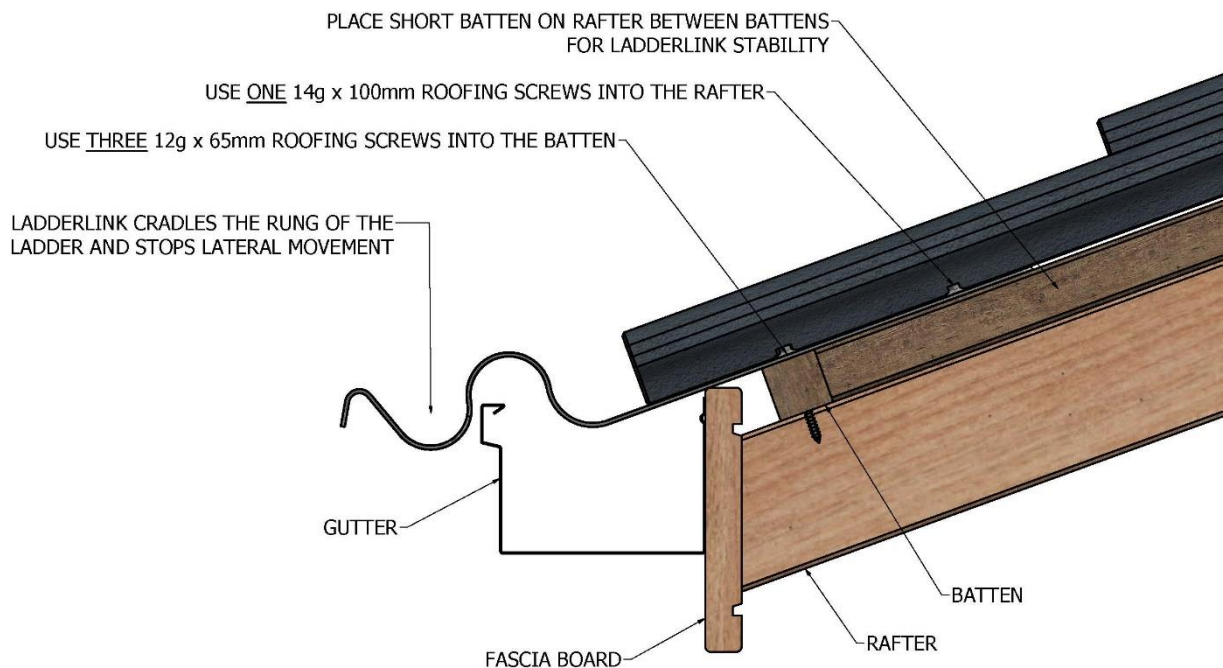



# FIXED LADDERLINK – WALL MOUNTED LADDER SUPPORT BRACKET

Wall Mounted - Product Code: LADFX003

- To install the LadderLink simply place in the desired location, ensuring there is suitable structure to support the brackets use.
- Once the ladder bracket is in the desired location, drill securing holes in both the LadderLink and mounting structure to suit method of attachment (see recommended fixing options below).
- Ensure that a minimum of four (4) appropriate fixings are used to anchor the ladder bracket to the structure.
- Fixings should be evenly spaced ideally 50mm in from the LadderLink edges to create a secure installation (see below diagram).

## FIXING TO TIMBER WALL/PARAPET

1. Drill and install 4 (four) 14g x 75mm roofing screws (recommended to pilot drill holes).
2. Ensure the timber structure is secured in accordance with current Building Codes.

## FIXING TO CONCRETE WALL/PARAPET

1. Drill and install 4 (four) M10 Dyna bolts or equivalent chemical anchor.
2. Ensure anchoring bolts are a minimum of 150mm from concrete wall edges.

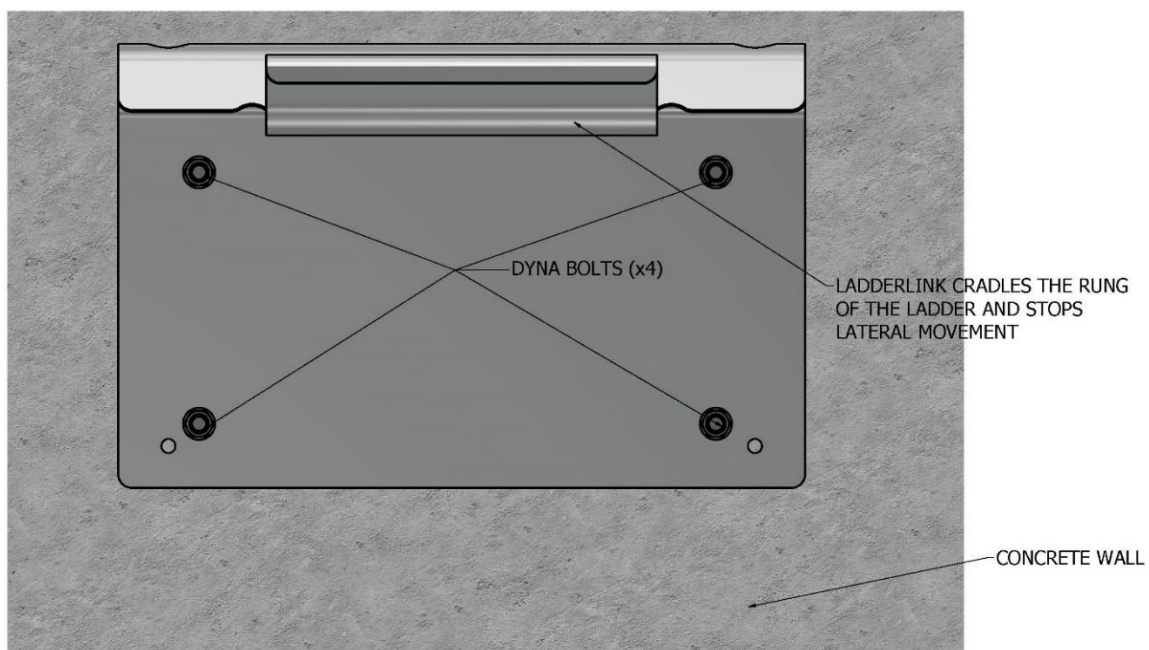
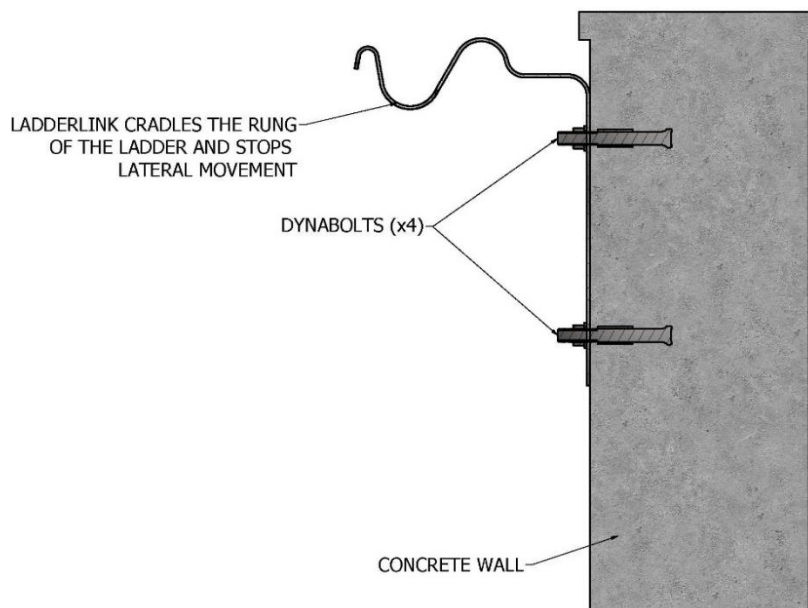

# APPENDIX – Diagram 2 – Anchor Positioning Layout

THIS IS A GUIDE ONLY

All working at heights safety procedures must be complied with when installing SafetyLink anchor points. For more information refer to your state or territories current legislation, regulations, policies and codes of practices.

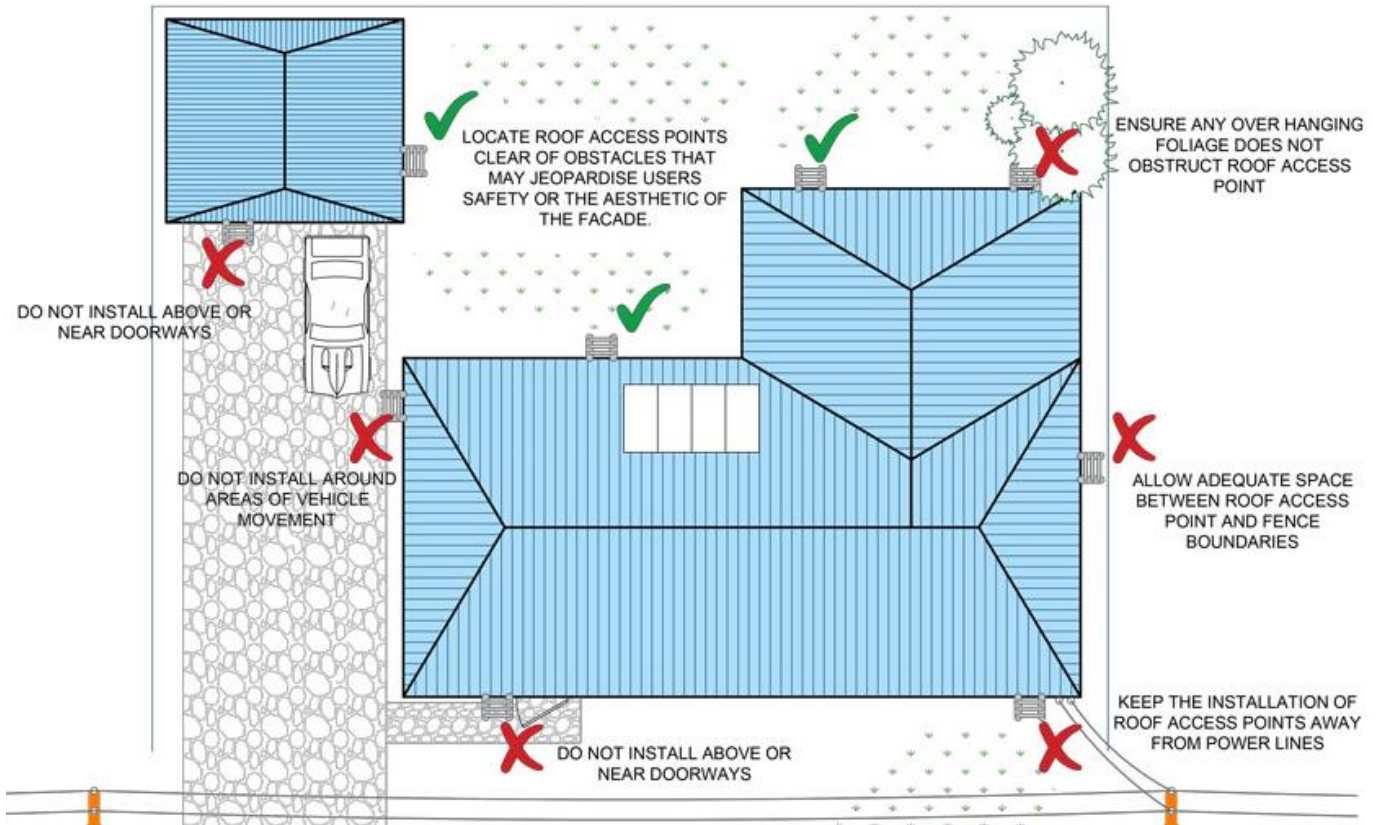

- ⚠ IF ANY DOUBT EXISTS WITH THE STRENGTH OF THE STRUCTURE OR ROOF SHEETS AN ENGINEER SHOULD MAKE THE ASSESSMENT.**
- ⚠ DURING INSTALLATION YOU MUST BE SAFE AT ALL TIMES.**
- ⚠ INSTALLATION MUST BE CARRIED OUT BY, OR UNDER THE SUPERVISION OF A COMPETENT HEIGHT SAFETY INSTALLER.**

## ACCESS, LAYOUT AND USE OF A SAFETYLINK ANCHOR SYSTEM

SafetyLink anchor points are positioned by calculating the pendulum effect, this limits the likelihood of a fall past the edge of the roof space. The pendulum effect still applies to a flat roof.

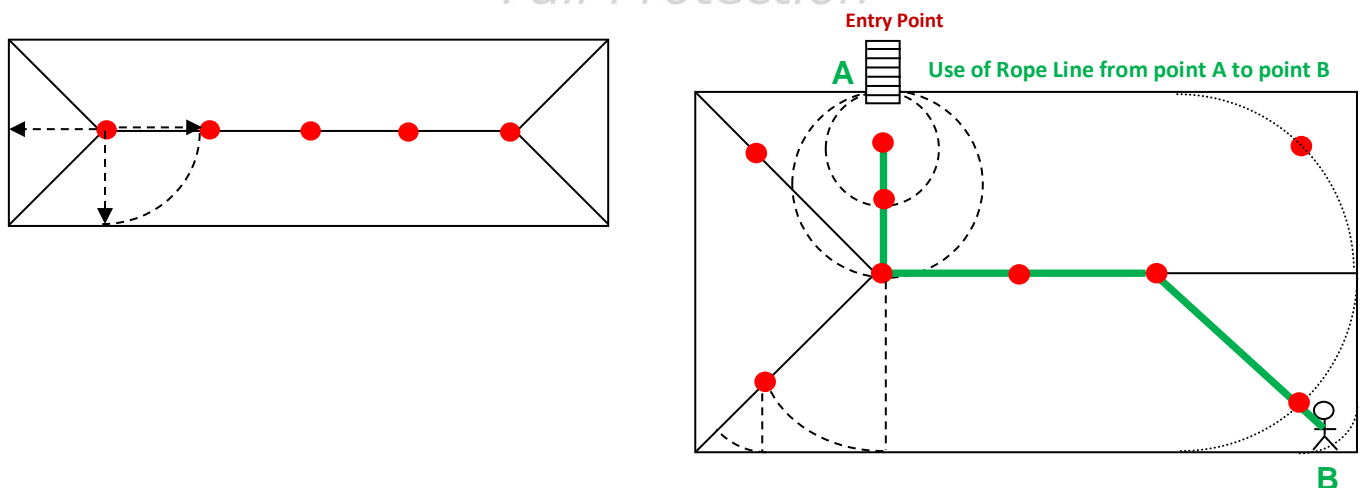

SPACING MUST BE NO GREATER THAN THE RAFTER LENGTH, PLEASE CONTACT YOUR DISTRIBUTOR IF YOU ARE UNSURE.

SAFETYLINK HEIGHT SAFETY SYSTEMS MUST ONLY BE INSTALLED AS PER OUR INSTALLATION GUIDES, TO STRUCTURES AS SPECIFIED IN THE INSTALLATION MANUAL FOR EACH PRODUCT. SHOULD ANY DOUBT EXIST IN REGARD TO THE STRUCTURES INTEGRITY AN ENGINEER SHOULD BE CONSULTED.



# EXPERT FALL PROTECTION PLANNING

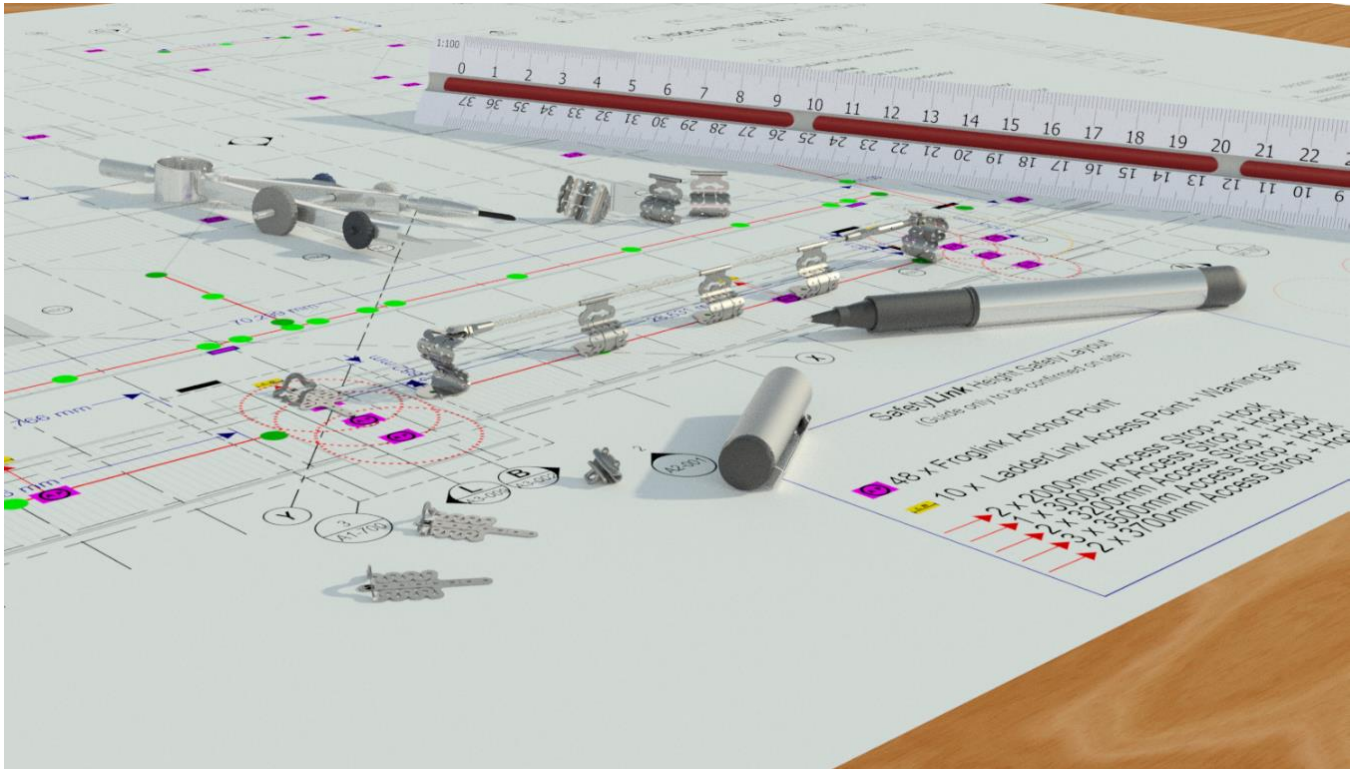

SafetyLink's design and planning team are here to help work out the positioning of your fall protection system, ensuring all areas of your roof are accessed safely.

Things to consider when planning your roof layout:

- Are all areas of your roof protected, allowing complete access when working at heights?
- Are you protected from the ground up, allowing complete access to your roof?
- Detailed comprehensive documentation provided e.g. installation guides, testing results, product sheets should be provided.
- SafetyLink can also provide you with a qualified and reputable installer of SafetyLink products.

Contact our design team at [info@safetylink.com](mailto:info@safetylink.com) and we can plan your fall arrest system for you.

© 2018, SafetyLink Pty Ltd, Australia.

Patents: SafetyLink Pty Ltd has a multitude of patents, patents pending, design applications, trademarks and copyrighted documents both lodged and issued. Should you wish to know the progress of our intellectual property on a specific product please email us on [ip@safetylink.com](mailto:ip@safetylink.com) and quote the product code.



## IN CASE OF ACCIDENT

---

**⚠ A FALL RESCUE PLAN AND SAFE WORK STATEMENT MUST BE DEVELOPED PRIOR TO USING SAFETYLINK SYSTEMS AND EQUIPMENT.**

**⚠ PERSONS WORKING AT HEIGHTS SHOULD NOT WORK ALONE.**

It is critical that before using any SafetyLink Systems a fall rescue plan is in place for any persons suspended mid-air following a fall. Serious injury or death can occur in a matter of minutes, particularly if a person's movement or breathing is restricted or loss of consciousness has occurred. In accordance with your fall rescue plan and appropriate first aid procedures it is essential to remove the person from the suspended position as quickly as possible.

### **IN ACCORDANCE WITH AS/NZS 1891.4:2009 CLAUSE 9.5**

#### **EQUIPMENT WHICH HAS ARRESTED A FALL OR SHOWS A DEFECT**

Any piece of equipment including both personal and permanently installed items, which has been used to arrest a fall or which shows any defect during operator or periodic inspection shall be withdrawn from service immediately and a replacement obtained if necessary. A label indicating the condition or defect should be attached to the equipment, and it should be examined by a competent height safety installer who will decide whether the equipment is to be destroyed or repaired if necessary and returned to service. In the latter case, details of any repair shall be documented, and a copy given to the operator.



**SafetyLink®**

*Innovative  
Fall Protection*



FS 707792

### **DISTRIBUTOR:**



**SafetyLink Pty Ltd | ABN 83 081 777 371**

**Phone: 1300 789 545 or +61 2 4964 1068 | Fax: 1300 738 071 or +61 2 49641069**

**info@safetylink.com | www.safetylink.com**